



2023 PRODUCT GUIDE





FLUID***ROWER*** **FLUID*****EXERCISE*** **FLUID*****POWER*****ZONE**



FDLIMITED.COM

CONTENTS

INDEX		2
FDF LIMITED - Who we are and what we do		3
Auto Detection of RESISTANCE LEVEL	NEW	4
 Bluetooth® Consoles - APP Connectivity	NEW	5
FDF FluidConnect APP	NEW	6
FDF Supported APPS		7
<hr/>		
FLUIDROWER		
 Bluetooth® Smart Box - Your device becomes the Console		8
EU-ROW®	NEW	9
HORIZONTAL Twin Tank - How Adjustable Fluid Resistance Works	NEW	12
HORIZONTAL Twin Tank FLUIDROWER - Range of Models	NEW	13
ANGLED / VERTICAL Twin Tanks - How Adjustable Fluid Resistance Works		14
ANGLED / VERTICAL Twin Tank FLUIDROWER - Range of Models		15
VORTEX VX-1FA - Wireless Adjustment for Fluid Resistance	NEW	16
VORTEX VX-3FA - Wireless Adjustment for Fluid Resistance		17
TABLET HOLDER - Stand Length - Accessory	NEW	18
XL TABLET HOLDER - Extra Long Reach - Accessory	NEW	19
TOUCH HEART RATE ROWING HANDLE - Accessory		20
PHONE HOLDER - ELEVATE KIT - SEAT BACK KIT - Accessories		21
FDF ACCESSORIES - Model Compatibility Guide		22
<hr/>		
FLUIDEXERCISE		
2023 - NEW LOOK and Features	NEW	23
Bi-Directional Arm Cycling - Benefits		23
FULLY ADJUSTABLE STANDING ARM CYCLE - E685	NEW	24
SQUAT PRESS - ESP & SKI ERGO - ESE	NEW	25
FLUIDEXERCISE - Range of Models		26
<hr/>		
FLUIDPOWERZONE		
2023 - NEW LOOK and Features	NEW	27
FLUIDPOWERZONE - Range of Models		28
CUBE - Olympic Training Platform	NEW	30
TRIPLE HIIT TRAINING SYSTEM	NEW	31

UPDATED 16 MAR 2023



ADJUSTABLE FLUID RESISTANCE MACHINES



FDF Limited is the leader in designing and manufacturing a range of adjustable Fluid Resistance fitness machines for commercial and residential applications.

At the heart of the fitness range is the unique and patented Twin Tank Fluid Resistance system. The Adjustable Fluid Resistance system challenged conventional thinking of how water could work to provide a broad range of adjustable resistance at any speed. The patented Twin Tank system provides silky smooth resistance at any speed and is perfect for cardio training, warm-ups, cool downs, intense HIIT workouts or rehabilitation programs.

FDF Limited categorizes the range of adjustable Fluid Resistance machines under the banners, **FluidRower**, **FluidExercise** and **FluidPowerZone**.

FDF Limited products are distributed throughout the globe and are popular in Fitness Centers, Hotels and Apartments, Sporting Clubs, Universities, First Responders, Defence Force Training Facilities and Physical Rehabilitation Clinics.

FLUIDROWER FLUIDEXERCISE FLUIDPOWERZONE

The unique branding of our extensive range of fitness machines will create easier brand recognition and consistency. The customer journey through our website will be cleaner and clearer, providing information and education on the customers specific areas of interest.

FLUIDROWER	FLUIDEXERCISE	FLUIDPOWERZONE
EU-ROW® Models	E650 ArmCycle - Fixed	FluidPower CLIMB
Neptune Models	E685 ArmCycle - Adj Height	FluidPower CUBE
Pacific Models	E750 Recumbent Cycle UBE	FluidPower ERG
Trident PRO V Model	E850 UBE - Seated	FluidPower PRESS
Neon Models	E950 Medical UBE - Seated	FluidPower ROW
Apollo Models	ESP Squat Press Machine	FluidPower UBE
Viking Models	ESE Ski Ergo Machine	
Mega Pro XL Model		
Evolution Models		
Vortex Models		

BROWSE THE RANGE AT [FDFLIMITED.COM](https://fdflimited.com)

2023 NEW FEATURES



AUTO DETECTION OF FLUID RESISTANCE LEVEL

All FDF Bluetooth FTMS consoles have automatic Resistance Level detection and display the selected level on screen. Your exercise metrics are automatically calibrated to the Resistance Level you choose. Review the model range pages following for a guide to FluidRowers with the Bluetooth FTMS consoles.



Console automatically changes to match resistance level selected



Selected level of Fluid Resistance



Horizontal Twin Tank

Angled / Vertical Twin Tanks

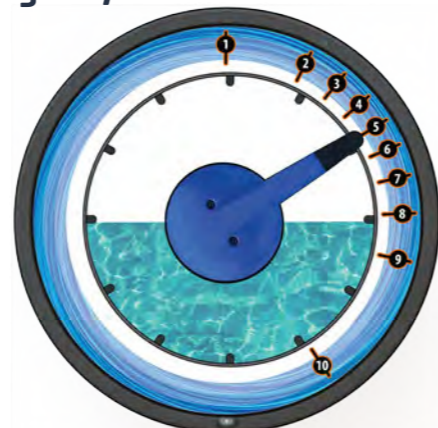
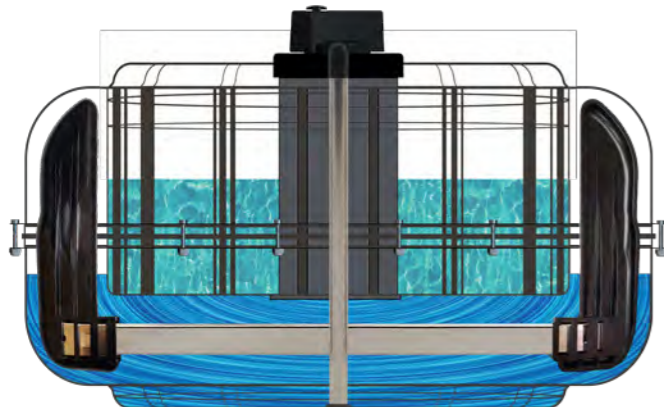

2023 NEW FEATURES

APP CONNECTIVITY

The FDF Bluetooth® FTMS consoles on FluidRowers, FluidExercise and FluidPowerZone bring compatibility with the world's best fitness APPs to you.

From simple row and record to on-demand coaching, you get to choose how to enhance your workouts across a huge range of options.

Bluetooth® CONSOLES WITH INTERACTIVE FUNCTIONS



FDF FLUID CONNECT APP

Fluid Connect APP allows you to record and review your workouts via the Bluetooth® FDF Consoles.

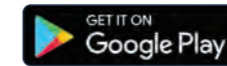
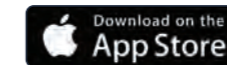

SUPPORTED APPS



FDF APP Connectivity Site



ASENSEI



CITY ROW



EXR



KINOMAP



REGATTA



ZWIFT



FDF FLUID CONNECT APP

Choose from a range of simple workout styles from just rowing to HIIT and review your session statistics and charts through the Session Log feature.

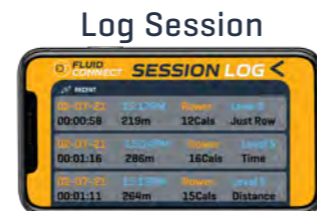
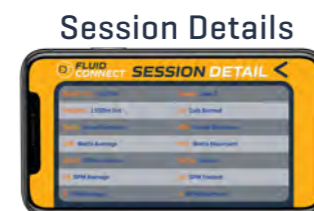
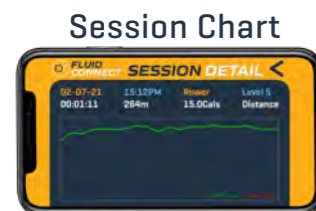
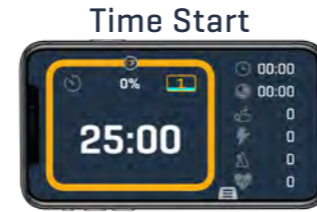
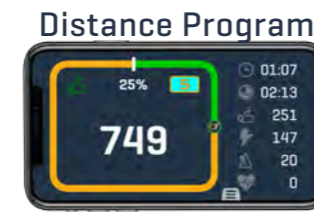
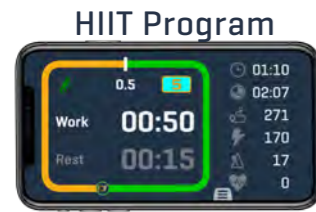
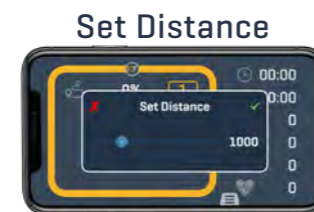
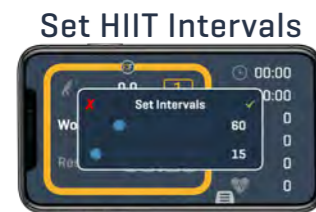
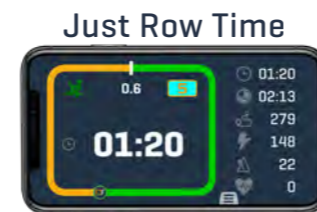
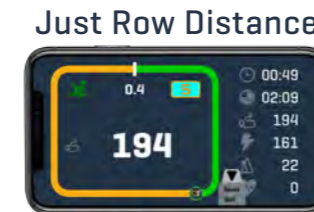
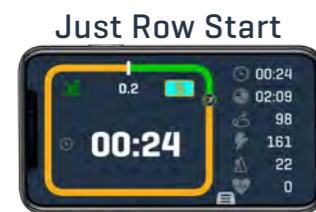
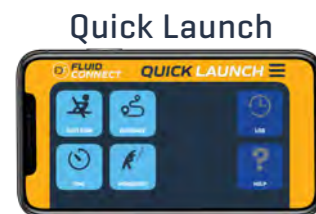

SUPPORTED APPS



KINOMAP
<https://www.kinomap.com/>

Kinomap is the world's largest geolocated video sharing platform, with thousands of videos from the best tracks around the world. Kinomap is the world's largest geolocated video sharing platform, with thousands of videos from the best tracks around the world. We pair to your equipment and respond to the inclines and resistance seen in the video on your screen. This isn't 'at-home training', this is the real thing.



EXR
<https://exrgame.com/>

EXR is an immersive indoor rowing experience. Get lost in the beautiful virtual world of EXR during your indoor rowing sessions. Row together with your friends or go on a solo mission. Test yourself with our professionally tailored workouts. Track & share your performances on Strava, Concept2 Logbook and Training Peaks.



ASENSEI
<https://asensei.com/>

PROGRAMS: Designed to challenge, improve, and adapted for each user, whether it's a 2km, 6km or 30min challenge. COACHING: Olympic Gold Medalist Eric Murray, British Rowing, Johan Quie, Shane Farmer of Dark Horse Rowing set the work; asensei makes it work. Watching, responding, adjusting, and encouraging. ANALYSIS: Row - record - watch - rewind - remember. asensei watches you move, as you move, responds in the moment, and evaluates and adapts over time.



REGATTA
<https://www.teamregatta.com/>

CONNECT & PERFORM Regatta is a performance-focused connected fitness app built by and designed for competitive athletes, fitness enthusiasts and goal seekers. Regatta is the first connected fitness brand to offer interactive group training across different exercise machine brands from the convenience of your mobile device. Regattas' coached classes focus on key metrics, such as pace, heart rate, and output. Coaches give tips on technique and guidance for calibrating in & out of class performance.





Bluetooth® SMART BOX

FOR EU-ROW® 1.1 & 3.1 MODELS

Our new Bluetooth Smart Box (BTSB) is a compact battery-operated device installed near the speed sensor of our FluidRower EU-ROW® 1.1 and EU-ROW® 3.1 models.

Rowing stroke metrics are transmitted directly to a user's mobile device and selected training APP.



* BTSB and Device Tablet Holder included with both the EU-ROW 1.1 and 3.1 Models.

* BTSB shown here on EU-ROW 3.1.

The BTSB can be manually powered on using the power button or by pulling the rower handle to activate the speed sensor. The BTSB can then communicate with nearby mobile devices using Bluetooth.

The BTSB is FTMS compliant, bringing compatibility with a growing number of popular fitness apps. Device software updates using our Fluid Connect app via Bluetooth DFU.

Currently compatible with V tank rowers with support for XL Tank, E350/550 and VX2/3 rowers coming soon.

* FDF reserves the right to modify any product design, manufacture or aesthetic without notice or consultation. Product specifications and warranties may vary from country to country.

BROWSE THE RANGE AT [FLUIDROWER.COM](https://www.fluidrower.com)



FLUIDROWER EU-ROW®

The result of long-term collaboration with a famous European design studio, our new EU-ROW® models are exquisitely engineered and crafted in only the finest materials.

Each EU-ROW® model delivers a new standard of finish for those who desire not only perfect function but also perfect form. Consider the curved and interlaced surfaces that enhance the strength and display a unique European aesthetic. Our new EU-ROW® Series gives you cutting edge technology and connectivity, with an unparalleled level of craftsmanship.



The EU-ROW® models have been engineered around our patented twin tank Adjustable Fluid Resistance tank. No other resistance system in the fitness market responds as well with a silky-smooth stroke at a constant resistance, at any speed, and at any load. The EU-ROW® has the sight, sound and feel of being on the water.

The EU-ROW® series uses only the highest quality American Ash, sourced from renewable and sustainable forests in north America. Each unique length of American Ash is crafted and finished into a unique EU-ROW® that will enhance the look and feel of any home.

The EU-ROW® is ready out of the box to accept your device, all your rowing metrics being recorded and stored on our free FDF FluidConnect App. A world of other Apps can be downloaded for coaching, entertainment and motivation.



EU-ROW® is available in limited numbers across both variations, these exclusive Adjustable Fluid Resistance Rowing Ergometers will enhance both your fitness and lifestyle.

* FDF reserves the right to modify any product design, manufacture or aesthetic without notice or consultation. Product specifications and warranties may vary from country to country.

BROWSE THE RANGE AT [FLUIDROWER.COM](https://www.fluidrower.com)

FLUIDROWER



EU-ROW® MODEL 1.1

The EU-ROW® 1.1 is made from the finest quality American Ash molded around a steel foot plate. The timber is twice sanded and lacquered to a high quality, furniture grade finish and the metal sections are coated with an industrial high-wear compound, the combination creating a chic European look that will enhance any home.

The 5 levels of resistance are provided by our patented FDF twin tank Adjustable Fluid Resistance system that is silky smooth through the entire stroke at any resistance level from feather light to Olympic intensity.

Bluetooth Smart Box links rowing data with your device as standard on all EU-ROW® models. See APP options at FluidRower.com



* FDF reserves the right to modify any product design, manufacture or aesthetic without notice or consultation. Product specifications and warranties may vary from country to country.

FLUIDROWER



EU-ROW® MODEL 3.1

The EU-ROW® 3.1 is exquisitely engineered in American Ash delivering a high-quality European aesthetic to enhance the look and feel of any home.

The 5 levels resistance are provided by our patented FDF twin tank Adjustable Fluid Resistance system that is silky smooth through the entire stroke at any resistance level from feather light to Olympic intensity.

Bluetooth Smart Box links rowing data with your device as standard on all EU-ROW® models. See APP options at FluidRower.com



* FDF reserves the right to modify any product design, manufacture or aesthetic without notice or consultation. Product specifications and warranties may vary from country to country.



HORIZONTAL TWIN TANK

HOW THE PATENTED TWIN TANK WORKS

PLUS Models
4 Levels



V Models
5 Levels



XL Models
10 Levels



Dial set for **MINIMUM** Fluid Resistance



Fluid in the inner **PASSIVE HOLDING** tank

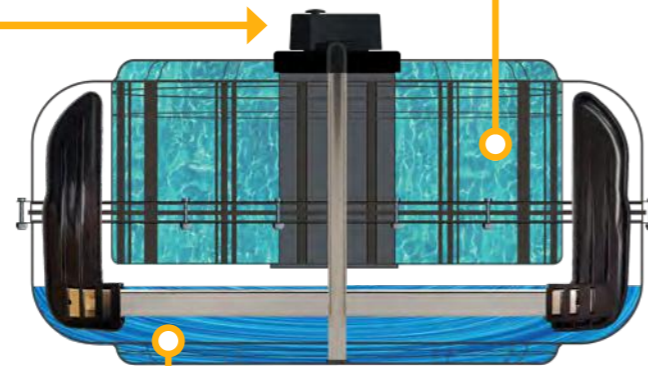

LOW Fluid in the outer tank **ACTIVE RESISTANCE**

Fluid in the inner **PASSIVE HOLDING** tank

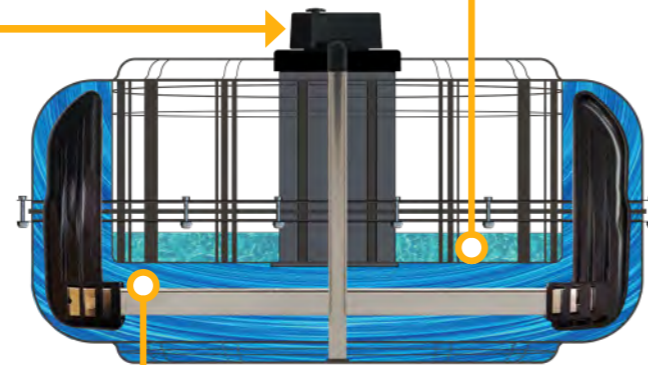

HIGH Fluid in the outer tank **ACTIVE RESISTANCE**



Dial set for **MAXIMUM** Fluid Resistance



HORIZONTAL TWIN TANK SERIES

- + VIKING Models - American Ash Wood Frame
- + APOLLO Models - Hybrid Steel/Wood Frame - American Ash Wood Side Rails & Steel Tank Frame
- + NEON Models - Steel Frame : Available in BLACK YELLOW GREEN & ORANGE Frames
- + "PRO" Models - SUITABLE FOR COMMERCIAL USE

RESISTANCE 4 LEVELS **CONSOLE** **HORIZONTAL 518mm TWIN TANK**

Neptune Plus

RESISTANCE 4 LEVELS **CONSOLE** **PLUS SERIES - HORIZONTAL 518mm TWIN TANK**

Pacific Plus NEON Plus NEON PRO Plus
Apollo Plus Viking 2 Plus Viking 3 Plus Apollo Plus Black

RESISTANCE 5 LEVELS **Bluetooth CONSOLE** **V SERIES - HORIZONTAL 518mm TWIN TANK**

Trident PRO V NEON PRO V Apollo V
Viking 2 V Apollo PRO V Viking 3 V Viking PRO V

RESISTANCE 10 LEVELS **Bluetooth CONSOLE** **XL SERIES - HORIZONTAL 518mm TWIN TANK**

Apollo PRO XL Viking PRO XL MEGA PRO XL

* FDF reserves the right to modify any product design, manufacture or aesthetic without notice or consultation. Product specifications and warranties may vary from country to country.



ANGLED / VERTICAL TWIN TANK

HOW THE PATENTED TWIN TANK WORKS

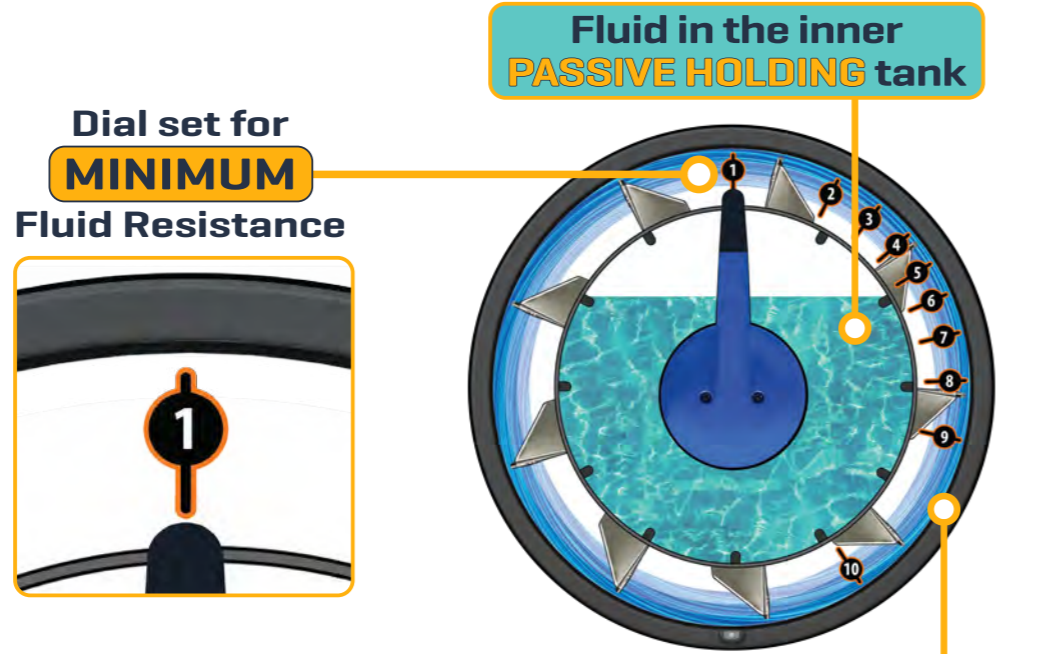

LOW Fluid in the outer tank ACTIVE RESISTANCE

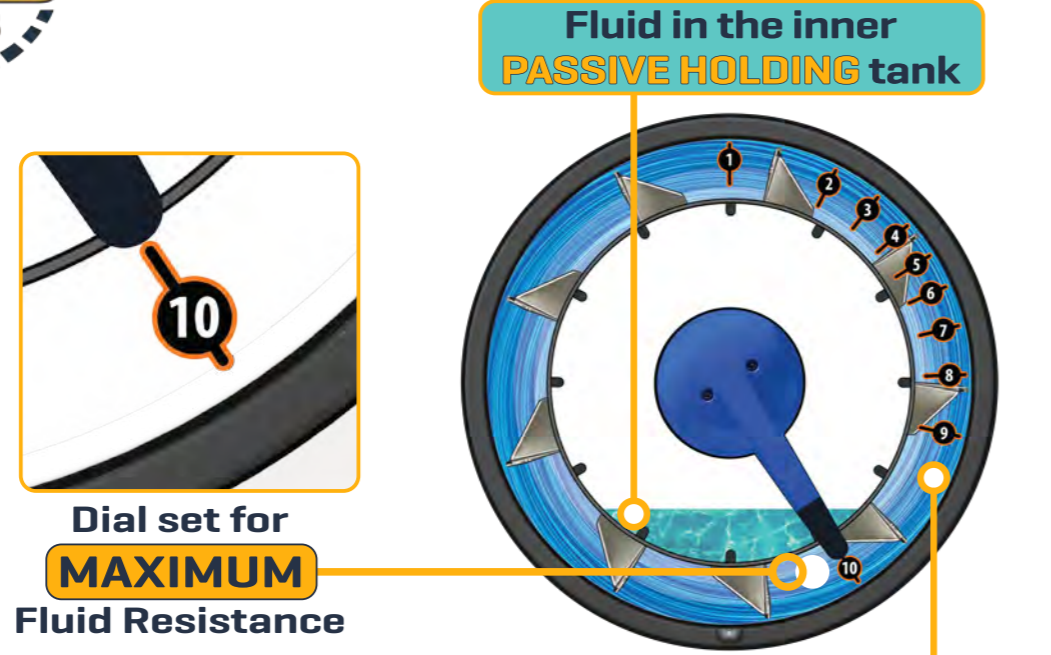

HIGH Fluid in the outer tank ACTIVE RESISTANCE



ANGLED / VERTICAL TWIN TANK SERIES

PREMIUM HEAVY DUTY COMMERCIAL LINE UP

EVOLUTION SERIES

- + Bluetooth® Console
- + Aluminum/Steel Frame
- + Vertical 525mm Twin Tank
- + Original Robust Industrial Design



VORTEX SERIES - Sculpted Aluminum Frame Profiles

- + Bluetooth® Console
- + Sculpted Aluminum/Steel Frame
- + Vertical 525mm Twin Tank
- + Deluxe Modern Aesthetic Design



*DF reserves the right to modify any product design, manufacture or aesthetic without notice or consultation. Product specifications and warranties may vary from country to country.

BROWSE THE RANGE AT [FLUIDROWER.COM](https://www.fluidrower.com)



VORTEX VX-1FA

FLUID ASSIST - WIRELESS FLUID RESISTANCE

Adjust the 16 levels of Fluid Resistance without taking your hands off the rowing handle, so you never miss a stroke. Changing the resistance on-the-fly has never been easier or more convenient.

The **FDF Vortex VX-1FA FluidRower Front Angled Twin Tank with Fluid Assist®** adjusts the Fluid Resistance levels via and buttons in the handle [pressed by your thumbs as you row] that communicate wirelessly with the motor built into the patented Twin Tank system.

WIRELESS FLUID RESISTANCE ADJUSTMENT BUILT INTO THE ROWING HANDLE

Adjust the 16 Resistance Levels at the touch of the & buttons

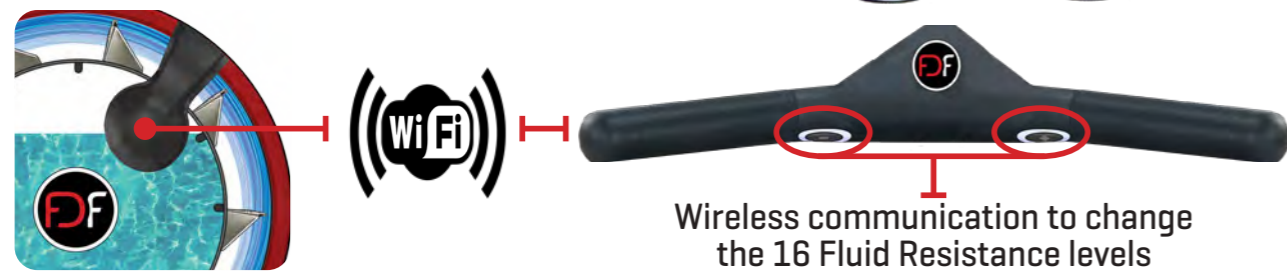

* FDF reserves the right to modify any product design, manufacture or aesthetic without notice or consultation. Product specifications and warranties may vary from country to country.



VORTEX VX-3FA

FLUID ASSIST - WIRELESS FLUID RESISTANCE

Adjust the 20 levels of Fluid Resistance without taking your hands off the rowing handle, so you never miss a stroke. Changing the resistance on-the-fly has never been easier or more convenient.

The **FDF Vortex VX-3FA FluidRower Side Vertical Twin Tank with Fluid Assist®** adjusts the Fluid Resistance levels via and buttons in the handle [pressed by your thumbs as you row] that communicate wirelessly with the motor built into the patented Twin Tank system.

WIRELESS FLUID RESISTANCE ADJUSTMENT BUILT INTO THE ROWING HANDLE

Adjust the 20 Resistance Levels at the touch of the & buttons



* FDF reserves the right to modify any product design, manufacture or aesthetic without notice or consultation. Product specifications and warranties may vary from country to country.



TABLET HOLDER - ACCESSORY

The FDF FluidRower Device Holder is fully adjustable to suit smart phones and tablets ranging in size from 15.2 cm to 33 cm / 6" to 13". The 360 Degree Device Holder rotation can accommodate Landscape and Portrait layouts and the fully adjustable tilt on two planes ensures the perfect viewing angle.



STANDARD BRACKET
TBH-S

Tablet Holder
150mm stem
fits frame
width from
75 - 118mm

PROFILE BRACKET
TBH-P

Tablet Holder
150mm stem
fits models
with profile
frames **PB**

PLUS SERIES - HORIZONTAL 518mm TWIN TANK

4 ADJUSTABLE FLUID RESISTANCE LEVELS

V SERIES - HORIZONTAL 518mm TWIN TANK

5 ADJUSTABLE FLUID RESISTANCE LEVELS

XL SERIES - HORIZONTAL 540mm TWIN TANK

10^{XL} ADJUSTABLE FLUID RESISTANCE LEVELS

* FDF reserves the right to modify any product design, manufacture or aesthetic without notice or consultation. Product specifications and warranties may vary from country to country.



XL LONG ARM TABLET HOLDER

The XL Long Arm Tablet Holder moves your device closer to your rowing action. Cleverly designed to ensure easy adjustment and still deliver absolute confidence your device stays in place. The perfect design of the XL model protects your tablet from the risk of unintended movement towards the path of the rowing handle. As with all FDF designs, the XL Long Arm Tablet Holder is practical, effective, aesthetically pleasing and made to exacting standards.



STANDARD BRACKET
TBH-SXL

Tablet Holder
XL STEM
fits frame
width from
75 - 118mm

PROFILE BRACKET
TBH-PXL

Tablet Holder
XL STEM
fits models
with profile
frames **PB**

PLUS SERIES - HORIZONTAL 518mm TWIN TANK

4 ADJUSTABLE FLUID RESISTANCE LEVELS

V SERIES - HORIZONTAL 518mm TWIN TANK

5 ADJUSTABLE FLUID RESISTANCE LEVELS

XL SERIES - HORIZONTAL 540mm TWIN TANK

10^{XL} ADJUSTABLE FLUID RESISTANCE LEVELS

* FDF reserves the right to modify any product design, manufacture or aesthetic without notice or consultation. Product specifications and warranties may vary from country to country.



TOUCH HEART RATE HANDLE

The FluidRower Touch Heart Rate Handle communicates accurate heart rate data directly from the handle to the console of your connected FluidRower. No cumbersome, uncomfortable, sweaty chest straps, no additional watch or hardware required, just hold on and row.

This world-first capability is packaged into a deluxe handle that monitors your heart rate per minute through the comfortable conductive handle grips and transmits it to the console in real time via **Bluetooth** technology.

Understanding your heart rate response to your rowing effort is the key to maximizing your fitness goals. Monitoring your heart rate on a rowing machine has never been this easy and convenient.

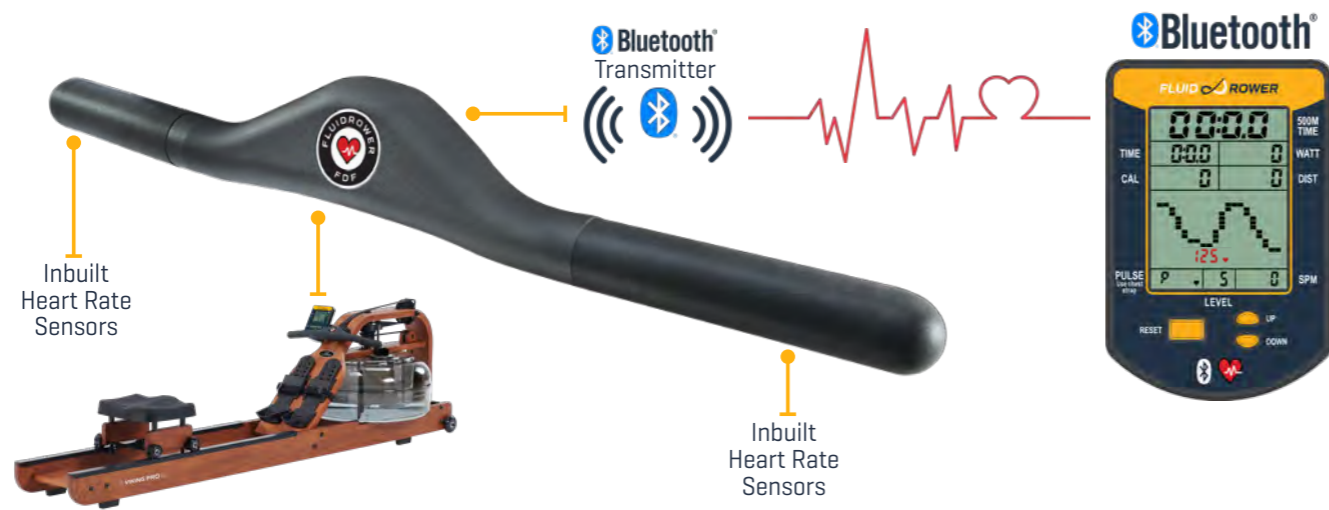

- DIMENSIONS: L 497mm [19.56"] x W 56mm [2.2"] x H 68mm [2.67"]
- HANDLE WEIGHT: 0.48kg [1.05lb]
- POWERED BY: 2 x AAA Batteries, can power handle for approximately 500 hours.
- COMPATIBLE WITH: V, XL, VORTEX and EVOLUTION series rowers fitted with FDF Bluetooth Consoles

* FDF reserves the right to modify any product design, manufacture or aesthetic without notice or consultation. Product specifications and warranties may vary from country to country.



SMARTPHONE HOLDER



FDF FluidRower Smartphone Holder cradles your mobile device right where you are looking, making it even easier to track and monitor rowing progress. An easy to install attachment with adjustability to securely fit any mobile phone. Enhance your experience by running the FluidRower App connected to the console.

ELEVATE KIT



FDF FluidRower Elevate Kit raises the rower rails and seat height, providing a more accessible entry and exit position. The Elevate Kit is ideal for the injured, aged, and less flexible exerciser. It's a quick, easy to add-on accessory that adds style and flair to your rower.

SEAT BACK KIT



FDF FluidRower Seat Back Kit is the ultimate solution to provide additional support to your lumbar spine. Perfect for the injured, deconditioned, aged or anyone needing some extra lumbar support. Instantly turns your rower seat into an office chair-like feel. Ergonomically contoured to match your natural shape. The Seat Back Kit is very easy to install and integrates flawlessly for a stylish finish.

ACCESSORY DISPLAY STAND



Ask about our subsidy program for the wooden display stand to promote the packaged accessories in store

* FDF reserves the right to modify any product design, manufacture or aesthetic without notice or consultation. Product specifications and warranties may vary from country to country.

ACCESSORY COMPATIBILITY GUIDE

RESIDENTIAL USE	TABLET HOLDER	TOUCH HEART RATE HANDLE	SMARTPHONE HOLDER	SEAT BACK KIT	ELEVATE KIT
Neptune Plus / Titan Plus					
Pacific Plus / Newport Plus					
Neon Plus	Ⓞ			Ⓞ	
Apollo Plus	Ⓞ			Ⓞ	Ⓞ
Viking 2 Plus	Ⓞ			Ⓞ	Ⓞ
Viking 3 Plus	Ⓞ			Ⓞ	Ⓞ
Apollo V	Ⓞ	Ⓞ	Ⓞ	Ⓞ	Ⓞ
Viking 2 V	Ⓞ	Ⓞ	Ⓞ	Ⓞ	Ⓞ
Viking 3 V	Ⓞ	Ⓞ	Ⓞ	Ⓞ	Ⓞ
EU-ROW	Ⓞ	Ⓞ	Ⓞ	Ⓞ	Ⓞ

COMMERCIAL USE	TABLET HOLDER	TOUCH HEART RATE HANDLE	SMARTPHONE HOLDER	SEAT BACK KIT	ELEVATE KIT
NEON Pro Plus	Ⓞ			Ⓞ	
NEON Pro V	Ⓞ	Ⓞ	Ⓞ	Ⓞ	
Apollo Pro V	Ⓞ	Ⓞ	Ⓞ	Ⓞ	Ⓞ
Apollo Pro XL	Ⓞ	Ⓞ	Ⓞ	Ⓞ	Ⓞ
Trident Pro V	Ⓞ	Ⓞ	Ⓞ		
Viking Pro V	Ⓞ	Ⓞ	Ⓞ	Ⓞ	Ⓞ
Viking Pro V	Ⓞ	Ⓞ	Ⓞ	Ⓞ	Ⓞ
MEGA PRO XL	Ⓞ	Ⓞ	Ⓞ	Ⓞ	
Evolution E350 / Vortex VX-2		Ⓞ	Ⓞ	Ⓞ	
Evolution E550 / Vortex VX-3		Ⓞ	Ⓞ	Ⓞ	

The complete range of FDF FluidExercise arm cycles / upper body ergo machines function perfectly in either forward or reverse, with the resistance and direction able to be altered “on the fly”.

The range of FDF FluidExercise machines is configured to meet all requirements; upper body warm-ups, rehabilitation, high intensity interval training (HIIT) and cardio workouts.

BI-DIRECTIONAL ARM CYCLING

The FDF Twin Tank Adjustable Fluid Resistance system provides silky smooth, consistent resistance in either direction at any speed.

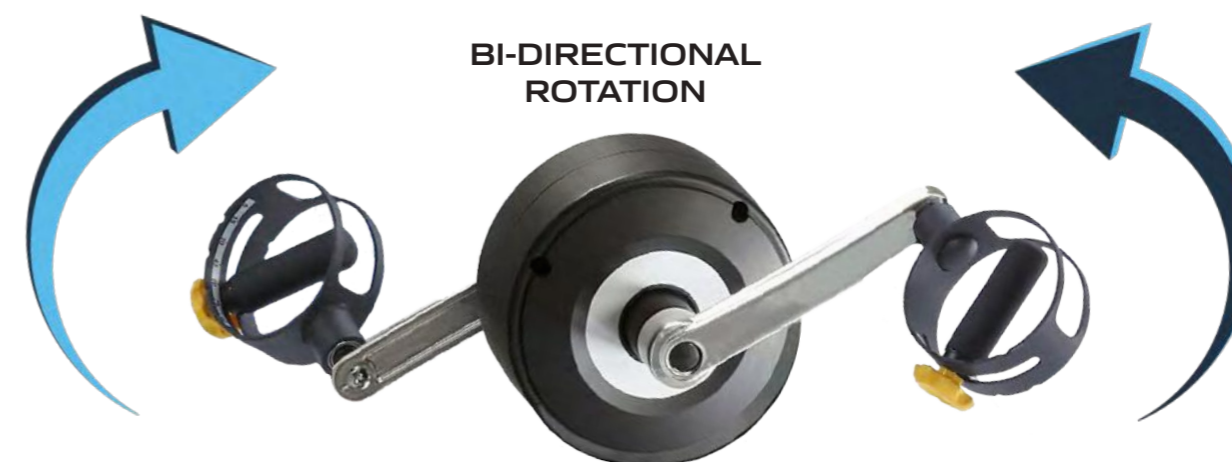

Change direction, speed or resistance “on the fly”.

2023 NEW FEATURES

NEW FLUID EXERCISE E685 FULLY ADJUSTABLE STANDING ARM CYCLE

NEW 2023 MODEL AVAILABLE IN **MIDNIGHT BLACK**

FLUIDEXERCISE NEW MODEL



▶ AVAILABLE IN **MIDNIGHT BLACK**

ARM CYCLE E685

FULLY ADJUSTABLE STANDING UPPER BODY ERGOMETER



Bi-directional rotation for complete muscle engagement

Bluetooth monitor

10 Levels of Fluid Resistance



Height adjustable crank position, gas assisted

BLACK FRAME

Wide footplates provide stability and foot placement range

Exercise placard

Transport wheels

Steel frame

BROWSE THE RANGE AT FLUIDEXERCISE.COM

* FDF reserves the right to modify any product design, manufacture or aesthetic without notice or consultation. Product specifications and warranties may vary from country to country.

FLUIDEXERCISE NEW MODEL



▶ SQUAT PRESS ESP SQUAT TO OVERHEAD PRESS

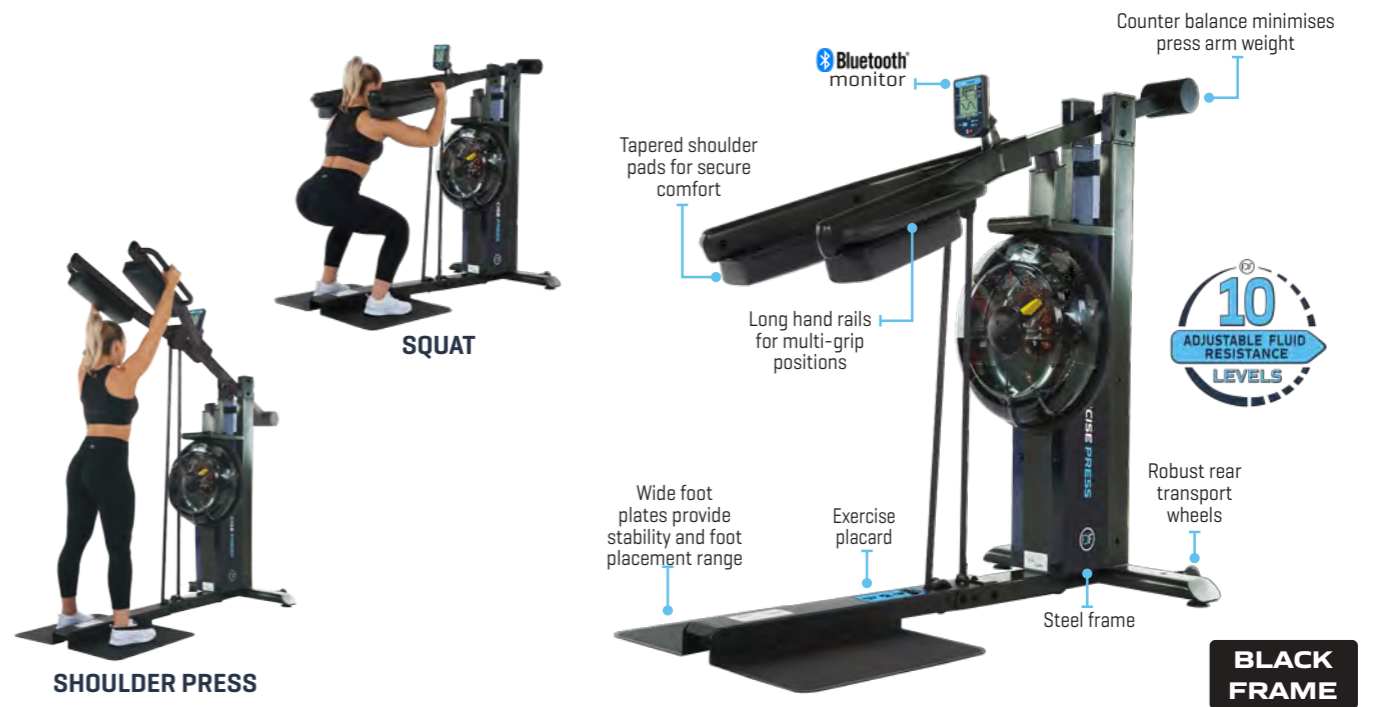

▶ SKI ERG ESE SKI ERGO MACHINE

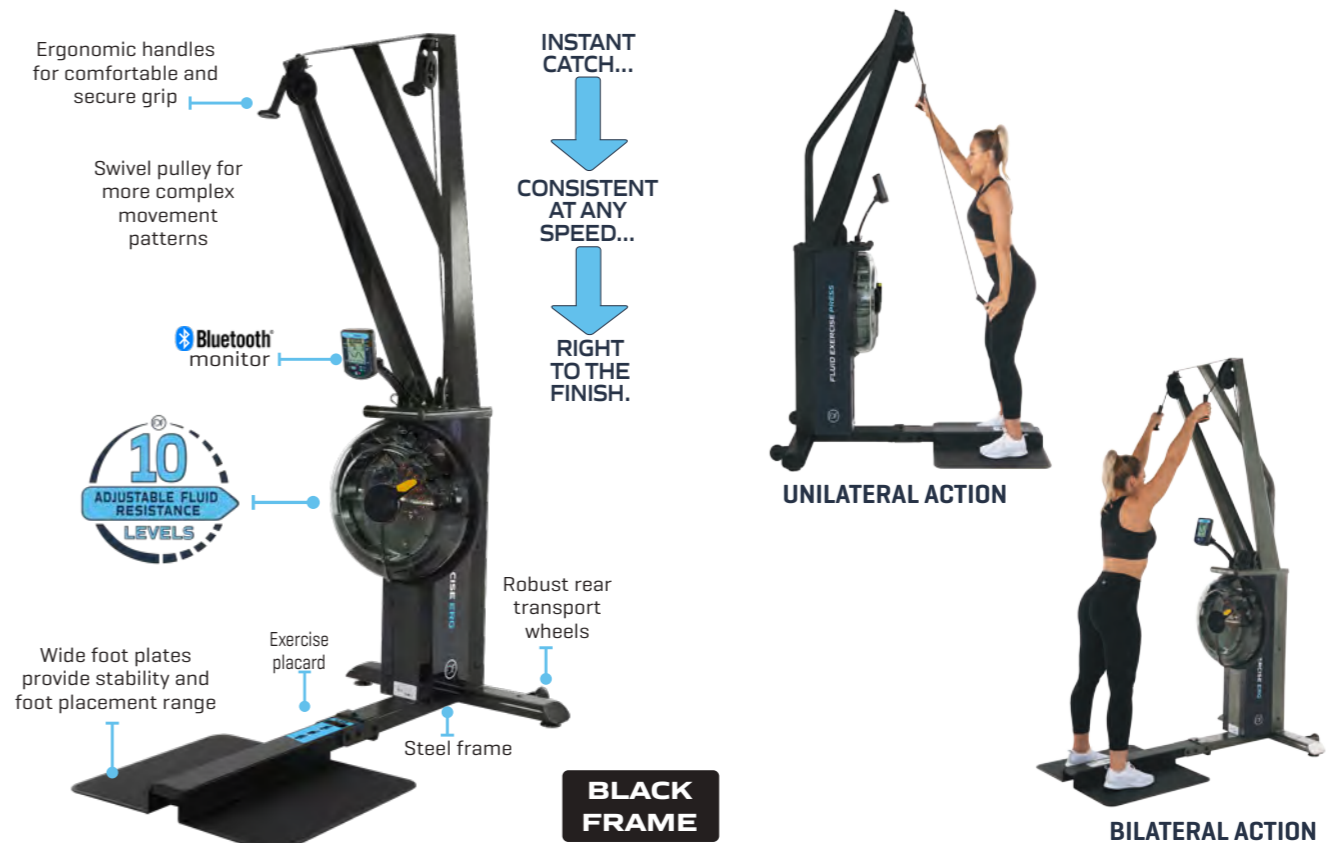

* FDF reserves the right to modify any product design, manufacture or aesthetic without notice or consultation. Product specifications and warranties may vary from country to country.

BROWSE THE RANGE AT FLUIDEXERCISE.COM

FLUIDEXERCISE



MODELS AVAILABLE IN MIDNIGHT BLACK

ARMCYCLE E650



UBECYCLE E750



UBE E850



MEDICALUBE E950



* FDF reserves the right to modify any product design, manufacture or aesthetic without notice or consultation. Product specifications and warranties may vary from country to country.

BROWSE THE RANGE AT [FLUIDEXERCISE.COM](https://www.fluidexercise.com)

FLUIDPOWERZONE



THE FDF FluidPowerZone Range of adjustable fluid resistance fitness machines are designed for training in any Zone - Cardio, Power, Strength or Speed.

The complete range of FDF FluidPowerZone machines can be used individually, or by combining multiple machines to make up unique classes or fitness circuits. There's no limit to the training options FluidPowerZone can deliver.

Key Market Segments where the FluidPowerZone Machine are being used:

- Athletic/Sports Clubs
- CrossFit HIIT Clubs
- Health Fitness Clubs
- Medical Rehabilitation
- Military/First Responders
- Active Ageing Centres

2023 NEW FEATURES

NEW 2022 MODEL AVAILABLE IN MIDNIGHT BLACK

NEW CUBE - ADD ON PLATFORM

NEW TRIPLE HIIT TRAINING SYSTEM

NEW INSTRUCTIONAL PLACARDS



NEW QR CODE - VIDEOS OF MACHINES IN ACTION



MODELS AVAILABLE IN MIDNIGHT BLACK

CLIMB CONTRALATERAL CLIMBER



CONTRALATERAL NATURAL ACTION



ERG SKI ERGOMETER



INSTANT CATCH



2023 MODEL AVAILABLE IN MIDNIGHT BLACK

PRESS SQUAT TO OVERHEAD



UBE STANDING ARM CYCLE



ROW TOTAL BODY ROWER



CUBE TRAINING PLATFORM



BROWSE THE RANGE AT [FLUIDPOWERZONE.COM](https://www.fluidpowerzone.com)

* FDF reserves the right to modify any product design, manufacture or aesthetic without notice or consultation. Product specifications and warranties may vary from country to country.

* FDF reserves the right to modify any product design, manufacture or aesthetic without notice or consultation. Product specifications and warranties may vary from country to country.

BROWSE THE RANGE AT [FLUIDPOWERZONE.COM](https://www.fluidpowerzone.com)

FLUIDPOWERZONE

CUBE OLYMPIC PLATFORM

The FluidPowerCUBE Olympic Platform add-on accessory provides an athlete with an Olympic bar height for all movement patterns.

Ideal for increasing squat depth for advanced athletes and increasing the range of motion for all ground-up movement patterns.

The CUBE Olympic Platform is manufactured from Marine grade plywood pressure tested to withstand the toughest of commercial environments. The cross-braced construction provides a sturdy platform for all your heavy lifts.

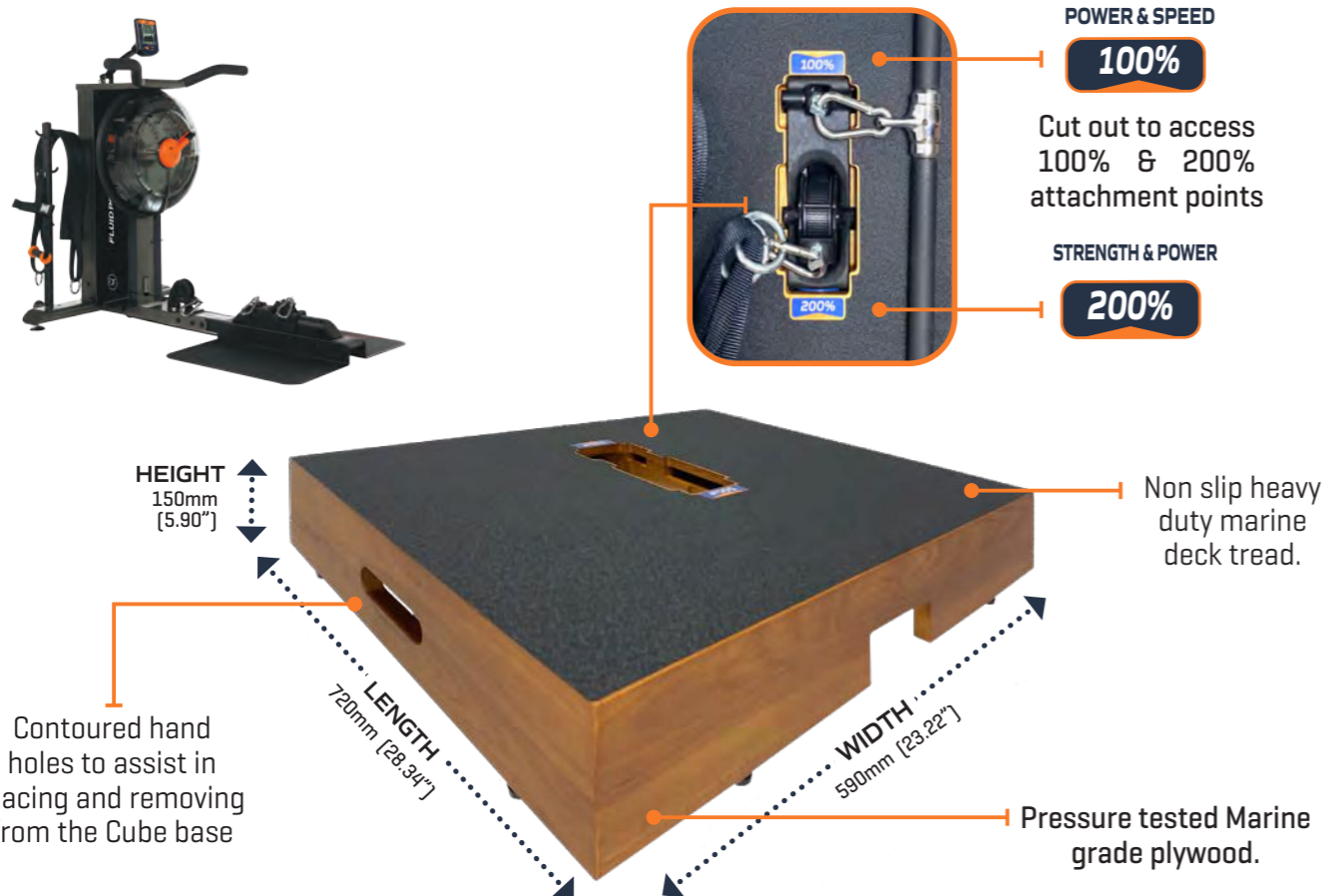

* FDF reserves the right to modify any product design, manufacture or aesthetic without notice or consultation. Product specifications and warranties may vary from country to country.

FLUIDPOWERZONE

TRIPLE HIIT SYSTEM

EFFECTIVE SOLUTIONS to the challenges of HIIT Training

- + Adjust the resistance and GO, ready for all shapes and sizes
- + Fluid Resistance responds to input effort, the user does not need to adapt to the machine
- + Train at any speed, there is no momentum, so the user cannot out-accelerate the resistance
- + Concentric Adjustable Fluid Resistance reduces recovery times
- + Train at peak power every single repetition, then recover and go again the next day

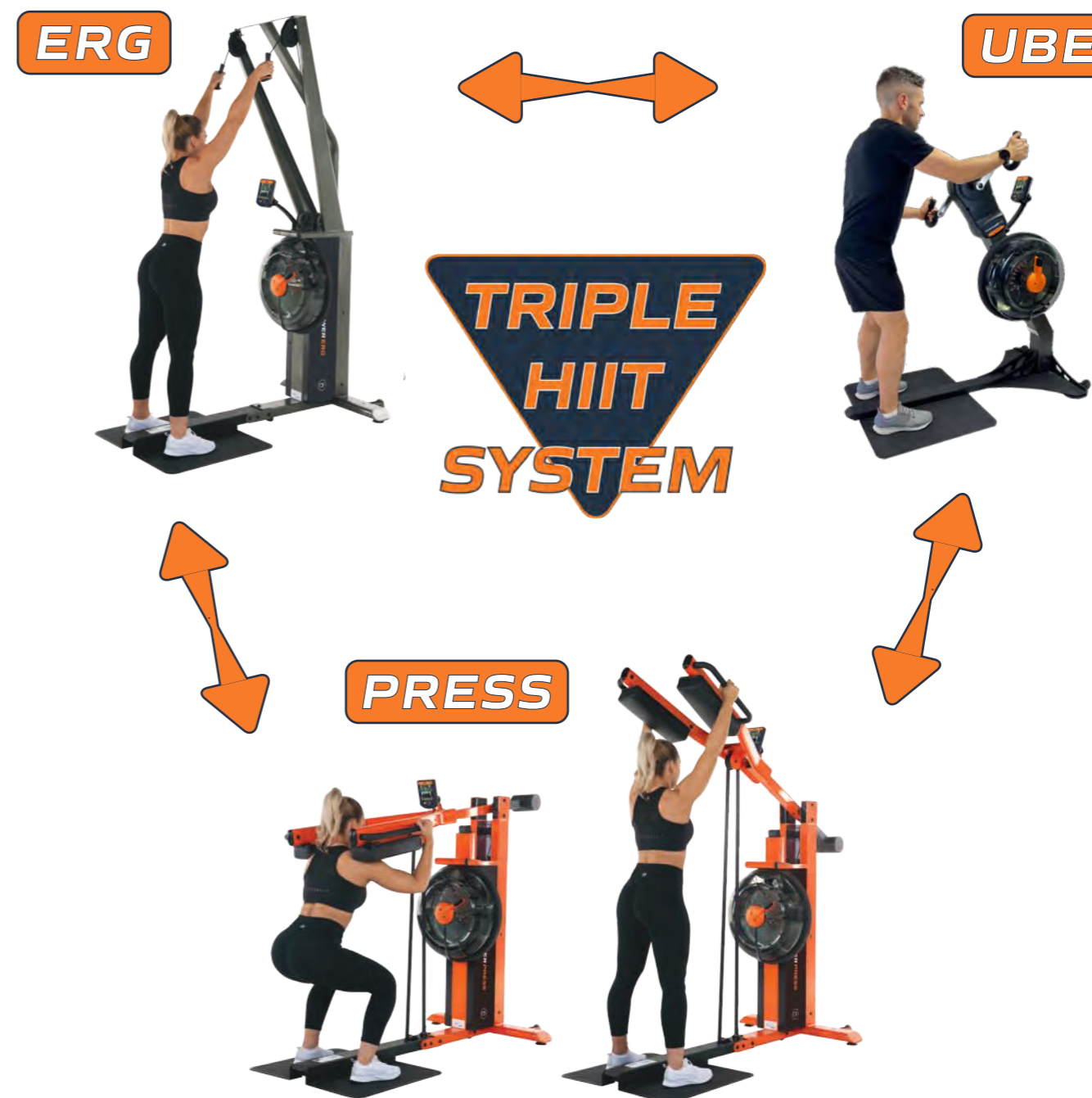



FLUIDROWER

FLUIDEXERCISE

FLUIDPOWERZONE

BROWSE THE RANGE AT [FDLIMITED.COM](https://www.fdflimited.com)

* FDF reserves the right to modify any product design, manufacture or aesthetic without notice or consultation. Product specifications and warranties may vary from country to country.